

HAKKI PILKE eagle

PILKKOJASIRKKELIN

- ASSEMBLY INSTRUCTIONS
- OPERATING INSTRUCTIONS
 - SAFETY INSTRUCTIONS
 - SERVICE INSTRUCTIONS
 - SPARE PART LIST
 - WARRANTY TERMS
 - EC DECLARATION
OF CONFORMITY

MAASELÄN KONE OY

Valimotie 1, 85800 Haapajärvi, Finland

Tel. +358 8 7727300, Fax +358 8
7727320

info@maaselankone.fi







www.maaselankone.fi









**These instructions must be read
before operating the machine!**

TABLE OF CONTENTS

The machine carries following markings	3
GENERAL SAFETY INSTRUCTIONS	5
Commissioning a New Machine	6
Installing the Cross-cut Cradle Extension	6
Adjusting the Cross-cut Cradle Inclination	6
Adjusting the Splitting Table	7
Connecting the Machine to a Tractor	7
Electrically Driven Circular Saw with Splitting Device	8
Start and Stop Buttons of the Electrically Driven Model	9
Test Run.....	10
Processing Firewood – General.....	11
Safety Precautions for Cutting:	11
Processing Firewood	12
Splitting	14
EMERGENCY STOP Device	16
Removing a Log Stuck on the Splitting Cone.....	18
Maintenance	18
Sharpening the Saw Blade.....	18
Blade setting	19
Pre-stressing the Blade	19
Removing the Saw Blade	19
Installing the Saw Blade.....	21
Adjusting the V-belts and emergency stop device	22
Lubrication.....	23
Transporting the Machine	24
Storing the Machine	24
Technical Specifications.....	25
Tractor-driven Circular Saw – Exploded View.....	26
Tractor-driven Circular Saw – Part List.....	27
Emergency Stop Device	29
Emergency Stop Device – Spare Part List	29
Electrically Driven Circular Saw – Exploded View	30
Electrically Driven Circular Saw – Spare Part List	31
Transfer Wheels – Exploded View	33
Spare Part List / Installing the Wheels on the Circular Saw	33
EC Declaration of Conformity on the Machine	34
WARRANTY TERMS:	35

The machine carries following markings

 <p>VAARA-ALUE</p> <p>DANGER ZONE</p>	 <p>VARO LEIKKAAVAA TERÄÄ</p> <p>BEWARE OF THE CUTTING BLADE</p>	 <p>VAIN YKSI HENKIÖ TYÖALUEELLA</p> <p>ONLY ONE PERSON AT A TIME IN THE WORK AREA</p>
 <p>SAMMUTA KONE ENNEN HUOLTOA</p> <p>SHUT DOWN BEFORE MAINTENANCE</p>	 <p>VARO KONEEN LIIKKUVIA OSIA</p> <p>BEWARE OF MOVING PARTS</p>	 <p>NIVELAKSELIIN KIETOUTUMISVAARA</p> <p>RISK OF ENTANGLEMENT WITH THE CARDAN SHAFT</p>

 <p>LUE OHJEKIRJA ENNEN KÄYTTÖÄ</p> <p>READ THE MANUAL BEFORE USE</p>	 <p>KÄYTÄ SUOJAVARUSTEITA</p> <p>USE PROTECTIVE EQUIPMENT</p>	 <p>KÄYTÄ SUOJAVARUSTEITA</p> <p>USE PROTECTIVE EQUIPMENT</p>
<p>MAX 540 RPM</p> <p>MAX RPM</p>	 <p>SCALE</p>	
 <p>PYÖRIMISSUUNTA VASEMMALLE</p> <p>LEFT ROTATION</p>		 <p>PYÖRIMISSUUNTA OIKEALLE</p> <p>RIGHT ROTATION</p>
 <p>NOSTOKOHTA TRUKILLE</p> <p>LIFTING POINT FOR FORKLIFT</p>	 <p>NOSTOKOHTA KOUKULLE</p> <p>LIFTING POINT FOR HOOK</p>	 <p>HÄTÄPYSÄYTYS</p> <p>EMERGENCY STOP</p>

GENERAL SAFETY INSTRUCTIONS

To avoid damage or injury, exercise extreme caution when operating this machine and when connecting the machine to a power source such as a tractor.

To avoid accidents, the machine must not be operated by persons who are intoxicated, under the influence of drugs, excessively tired, or otherwise not in sufficient control of their actions.

Connection of the machine to the power source, such as a tractor, must be carried out by only one person at any one time. The danger zone around the machine is 10 metres. Except for the person connecting the machine or the operator, no other person is allowed within this area during connection and operation. Do not leave the machine running unsupervised!

If a person other than the operator remains within the risk zone, the operator must make them aware of the dangers related to the operation of the machine.

The work area, including the ground surface, must be prepared prior to operating the machine to ensure safe working conditions.

The Hakki Pilke circular saw with splitting device is designed for making firewood from delimbed trees or other pre-processed wood, such as pre-cut logs. Do not use wood that has been processed in any other way, such as construction waste. The machine manufacturer is not liable for any damage or injury to the machine or operator caused by processing such wood.

The required log length for **splitting** is 30–40 cm.

The maximum thickness for both splitting and cutting is 25 cm.

The maximum log length for cutting is 4 metres.

The machine may be operated only by persons who are:

- familiar with these instructions;
- familiar with the risk situations that may occur during operation of the machine;
- familiar with what to do in the event of a dangerous situation during operation.

If the machine is faulty or contains a broken part that the operator is not able to repair or replace, the operator must contact the seller, manufacturer or importer of the machine.

The operator must always check all components before connecting the machine to the tractor or operating it. Under no circumstances should the machine be used if wear or cracks are detected in its structure or components.

Any faulty parts must be repaired or replaced with new ones.

Commissioning a New Machine

Dispose of all machine packaging in an environmentally responsible manner.

Installing the Cross-cut Cradle Extension



1. Slot the cross-cut cradle extension into the square pipe on the cradle frame.



2. Adjust the extension to the desired length and secure it in place with the locking nut.

Adjusting the Cross-cut Cradle Inclination



Adjust the cradle's extreme position (towards the user) using the nut on the lower part of the cradle. There should be approx. 3 mm between the cradle cover and the rocking cover.

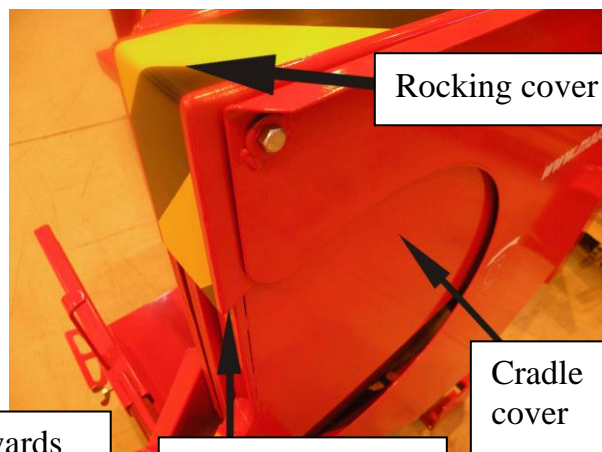

Rocking cover

Cradle cover

Approx. 3 mm

Adjusting the Splitting Table



The splitting table distance can be adjusted using the adjustment nut at the bottom of the table.

Never set the splitting table distance so that the tip of the splitting cone protrudes from the table cover! Set it as shown in the figure!

Connecting the Machine to a Tractor

Always make sure you are on your own when connecting the machine. Make sure that the tractor cab is free of people or animals (e.g. dog) which might accidentally nudge the controls during connection. Before connection, check all connection components of the tractor and machine. Any faulty parts must be repaired or replaced with new ones. Connecting the machine to faulty devices or parts is strictly forbidden. To avoid human error, always carry out the connection carefully and systematically without interruption, making sure nothing is missed. Secure the connection pins with the appropriate cotters. After finishing the connection, check that the procedure has been completed successfully. When connecting the PTO shaft, follow the instructions for safe connection provided by the shaft manufacturer.

Connecting an unshielded shaft to the machine is strictly forbidden!

The following figure shows the tractor attachment points and the PTO input shaft location.

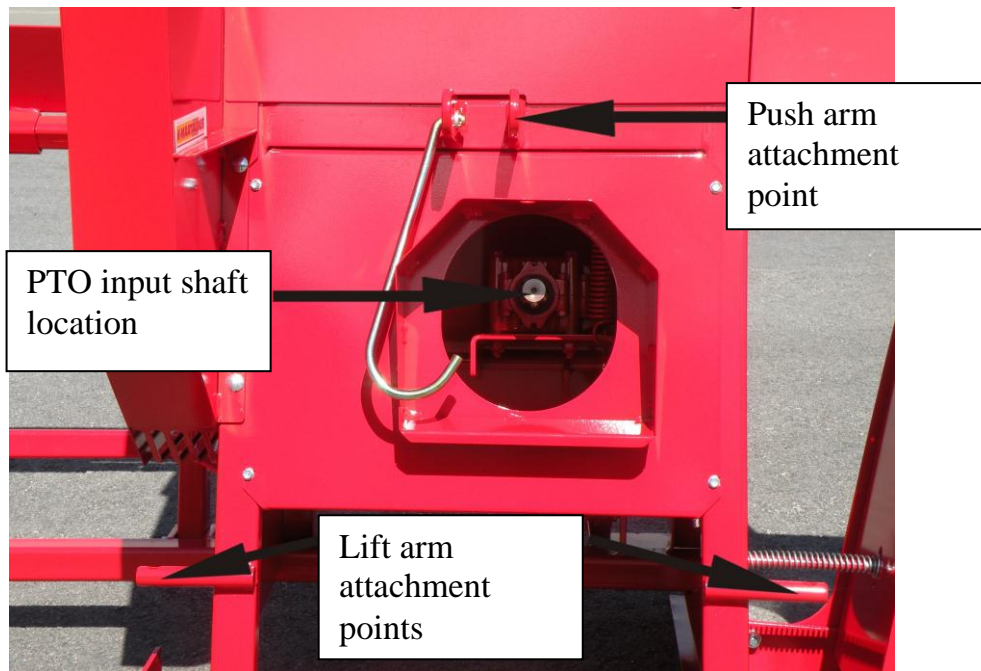

Electrically Driven Circular Saw with Splitting Device

In addition to the operation, maintenance, and safety instructions presented in this manual, the following must also be considered when commissioning and operating an electrically driven circular saw with splitting device:

The machine must be placed on a secure base to prevent tipping.
Operating the machine on a slope or otherwise inclined surface is forbidden.

The machine is equipped with a 4 kW electric motor and is fitted with a safety switch and start/stop switch. The plug current rating of the machine is 16 A, and the required fuse rating is 10 A (slow). Use of a residual-current device is recommended.

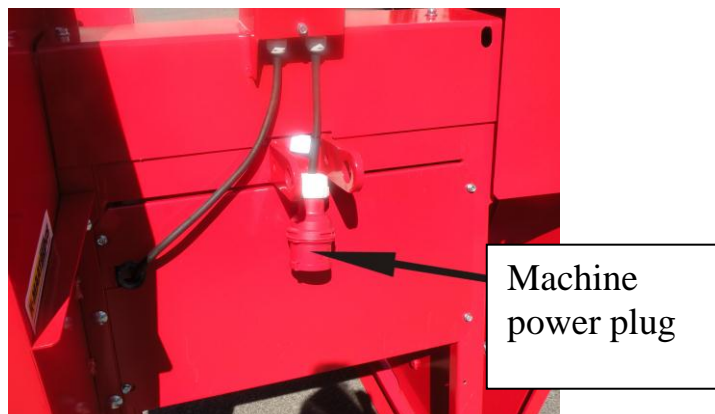

Ensure safe electric connection of the machine:

- The extension cord must be of sufficient rating and must be intact.
- If the extension cord is in danger of being walked on or driven over, it must be buried or covered with an appropriate protective material across the entire width of the route.
- Always route the power cord to the side that the machine's power plug is located.

If the extension cord is routed to the machine via the side you are working, the cord must be buried carefully and covered so that it cannot be touched while working.

- The cord coming to the machine must be long enough, and it must not be strained when the machine is moved.

Start and Stop Buttons of the Electrically Driven Model

The start box is on top of the shaft cover, to the left of the blade.

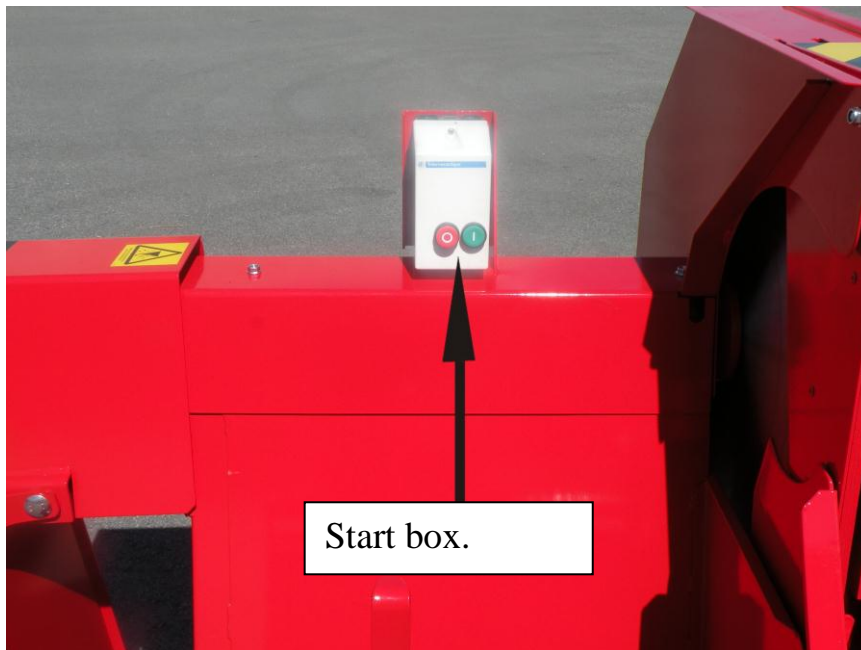

The machine **start button** is the **green** button on the box.
The **red** button is the **stop button**.

Make sure that the motor starts running in the correct direction when you start it!
The correct direction of rotation is marked on the blade cover.
After replacement of the power plug, the machine must always be started so that it can be stopped immediately if the motor's direction of rotation is incorrect.

The motor's rotation direction may be reversed only by persons authorised to do so.

Never move a running machine! The machine must always be stopped before moving it!

Never stop a rotating saw blade or splitting cone with wood, other object or with your hand. The blade shaft will rotate for a while after the motor is switched off. Let it rotate and wait until the machine has stopped completely.

The machine must always be stopped for service or cleaning.

Test Run

A test run must always be carried out before putting the machine into operation.

1. Without using wood, check that the splitting cradle moves **freely** to the end of its travel distance, and then returns to the initial position by itself. For adjusting the splitting cradle, see page 5!
2. Check that the cross-cut cradle moves **freely** to the end of its travel distance, and then returns to the initial position by itself. For adjusting the cross-cut cradle, see page 4! If the cradles do not operate properly despite adjustments, contact the manufacturer or the seller of the machine.
3. Start the machine. If the machine is tractor-driven, set the machine to correct rotation speed by adjusting the tractor's engine speed (PTO shaft speed: 540 rpm). An electrically driven machine rotates automatically at the correct speed!
4. Check that the emergency stop functions properly. See the instructions on operation/testing (page 13) and adjustment (pages 19–20).

Processing Firewood – General

You can begin making firewood if:

- You know how the machine operates.
- You are familiar with all operational safety aspects of the machine.
- You are wearing the following appropriate protective clothing and equipment:
 - safety boots with non-slip soles;
 - gloves that give a firm, secure grip on the wood;
 - suitable clothes that are not too loosely fitting;**Beware! Loose clothing can get caught in the wood, machine, etc., and cause accident!**
- appropriate face and eye shields and hearing protectors.
- You have prepared and maintained the work site such that it is level and safe to work on.
- You have taken appropriate precautions if working in extreme hot/cold temperature conditions.
- You are certain that the weather conditions, such as rain or snowfall, pose no risk to yourself or the machine.
- You are certain that the wind conditions pose no risk to yourself or the machine during operation.
- You have ensured that the work environment is sufficiently illuminated to prevent accidents during connection, operation, transportation, and storing of the machine.

Safety Precautions for Cutting:

- Only lift logs onto the cross-cut cradle that you are able to lift safely.
- Lift larger logs onto the cross-cut cradle in two steps, as described below.



1. **Lift the stump end onto the rollers (always feed large logs stump end first)!**
2. **Lift the top end. Lift with your legs, not with your back!**



3. Push the tree forward on the rollers.

- Cutting more than one log at a time, e.g. log bundles, is strictly forbidden!
- Never stop the saw blade by forcing a piece of wood or other object against the side or teeth of the saw blade.

Processing Firewood

Once you have connected the machine to the power source as described in these instructions and have familiarised yourself with all of the safety precautions required for operating the machine, you can begin making firewood.

1. Check that the cross-cut cradle and splitting table are adjusted as instructed on page 4.

2. Adjust the log length measuring device as follows:

1. Loosen the locking nut of the measuring device.
2. Slide the measuring device's stop bar to the desired position; use the length-indicating sticker to determine the correct position.
3. Tighten the locking nut of the measuring device.



3. With the tractor's engine idling, engage the PTO by lifting the clutch pedal up smoothly. Increase the engine speed but keep the PTO speed no higher than 540 rpm.
4. Choose a log that is light enough to lift safely, and lift it onto the cross-cut cradle ready for cutting.
If the log is warped, knotty, gnarly, too long, or otherwise dangerous to process as-is, pre-process the log with a chain saw to make it safe to put through the firewood processor.
5. Pull the cross-cut cradle to its rear position and place the log in the cradle.

6. Push the log to be cut against the measuring device stop bar.



7. Hold the log in the cradle with one hand and push the cradle smoothly and steadily towards the saw blade until the log is cut through.

8. Repeat the process, cutting several logs into the collector through. Do not overfill the collector through!

When cutting, make sure the level of cut logs in the collector through does not rise high enough to obstruct the log being sawn.

Splitting

Note! Grip the handle with both hands as soon as the the splitting cone has penetrated the log and splitting has begun, as shown opposite.

Hold the log in place with one hand only during the initial stage of splitting when the wood is pushed towards the splitting cone, as shown below.





Rack for thin wood



Rack for thick wood

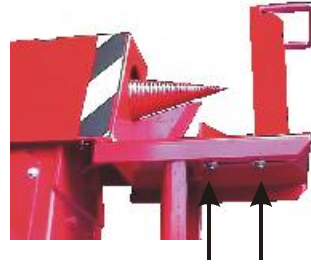

The distance of the rack from the cone can be adjusted with the nuts below the rack

Place the log to be split in an upright position on the splitting rack as shown in the figure.

When using the splitting cone, always:

- Place the log properly in the splitting rack and push the log against the cone with the rack.
- Do not split logs shorter than 30 cm or longer than 40 cm.
- Avoid splitting gnarly, knotty, or warped logs as they are tougher and hard to split. They are also more likely to become wedged onto the cone or onto the guide wedge beneath the cone.

- NEVER stand as shown below while splitting – the log can jump free of the rack and cause injury!



ALWAYS STAND BEHIND THE WOOD WHEN SPLITTING

**NEVER POSITION YOURSELF:
ABOVE THE LOG OR BESIDE THE RACK**

EMERGENCY STOP Device

The emergency stop pedal is located on the bottom corner of the collector through. In the event of hazard during machine operation, press the pedal fully down, ensuring that it latches in the down position. See the figure below! The machine must be stopped within **10 seconds!**



After stopping the machine with the emergency stop pedal, calmly switch off its power source, e.g. the tractor.

REMEMBER! The emergency stop pedal has stopped the machine so there is no need to rush to shut off the power. **IN SHORT:**

IN A DANGER SITUATION:

- 1. STOP THE MACHINE WITH THE EMERGENCY STOP PEDAL BY PRESSING THE PEDAL FULLY DOWN SO THAT IT BECOMES LATCHED.**
- 2. CALMLY SWITCH OFF THE MACHINE'S POWER SOURCE.**
- 3. REMOVE THE CAUSE OF DANGER.**

After removing the cause of the danger, activate the machine by releasing the locking latch and by lifting the emergency stop pedal to its upper position.



1. Release the locking latch by lifting the lifting bolt diagonally upwards!

2. Lift the emergency stop pedal to its upper position!

REMEMBER! USE THE EMERGENCY STOP PEDAL IN A DANGER SITUATION ONLY! NEVER USE IT FOR SERVICING PURPOSES, E.G. WHILE SHARPENING THE SAW BLADE!

NOTE! Models with an internal combustion engine are equipped with a separate emergency stop device!

Removing a Log Stuck on the Splitting Cone

If pulling the splitting table backwards fails to remove the log from the cone, stop the machine by switching off its power source.

1. Use an axe to split the stuck log off the cone. Use the right amount of force and precision to avoid damage or injury to the machine, the axe, or yourself.
2. If the wood does not come free with the axe, cut the wood into smaller pieces with a hand saw or chain saw, taking extreme care to avoid injuring yourself or damaging the saw or the machine.

Maintenance



Note! The machine must always be disconnected from the power source (by disconnecting the PTO shaft or electrical cable) before servicing!

Sharpening the Saw Blade

Keep the blade sharp:

- a sharp blade will cut quicker and with less power;
- a badly dulled blade heats up during cutting and may thus lose its pre-stressing;
- less cracking between teeth occurs with a sharp blade.
- Use for example a 6" v-cut barette file for sharpening.

- Keep the original:

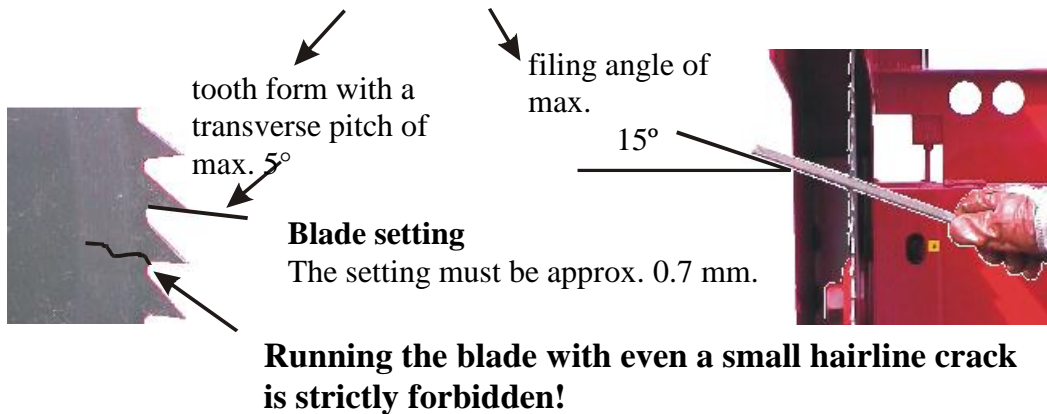

Pre-stressing the Blade

- If the blade has lost its pre-stressing, replace the blade with a new one or take it to a professional blade doctor for pre-stressing.

Removing the Saw Blade

Always wear gloves when handling the blade, taking care not to harm yourself, the machine, or the blade.





2. Remove the cradle inclination adjustment nuts.



3. Lower the cradle.



4. Lock the blade in place by placing, for example, a tool or piece of wood in the lower part of the cutting opening, between the machine frame and the teeth of the blade. (Note! If using a metal object to lock the blade, be careful not to damage the blade teeth!)

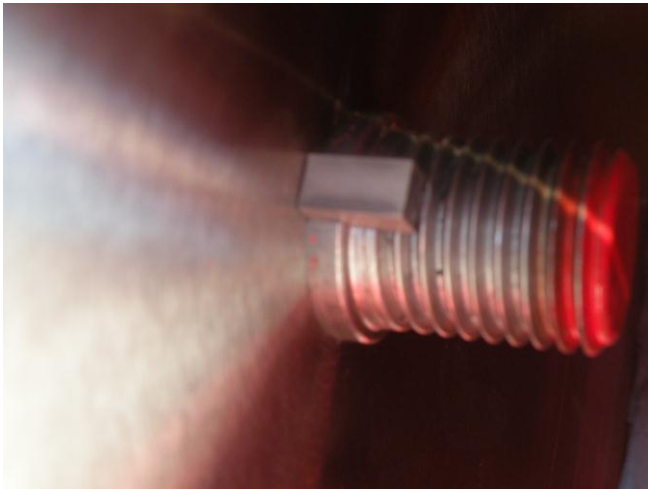

5. Remove the nut, the flange resting against the blade and the key on the shaft.



6. Remove the blade through the opening in the machine frame. Remember to wear gloves when handling the blade!

Installing the Saw Blade

Install the blade by carrying out the removal procedure in reverse order. Remember to install the key in the support flange!

Note! Always use the machine with blades complying with EN 847-1:1997!

Adjusting the V-belts and emergency stop device

The emergency stop system uses a brake pad to accelerate machine stoppage by forcing the V-belts against a stop block. The distance between the brake pad and stop block is set with the stopper attached to the stop block. When tightening the belts, adjust the brake pad stop block also. See the figure below.

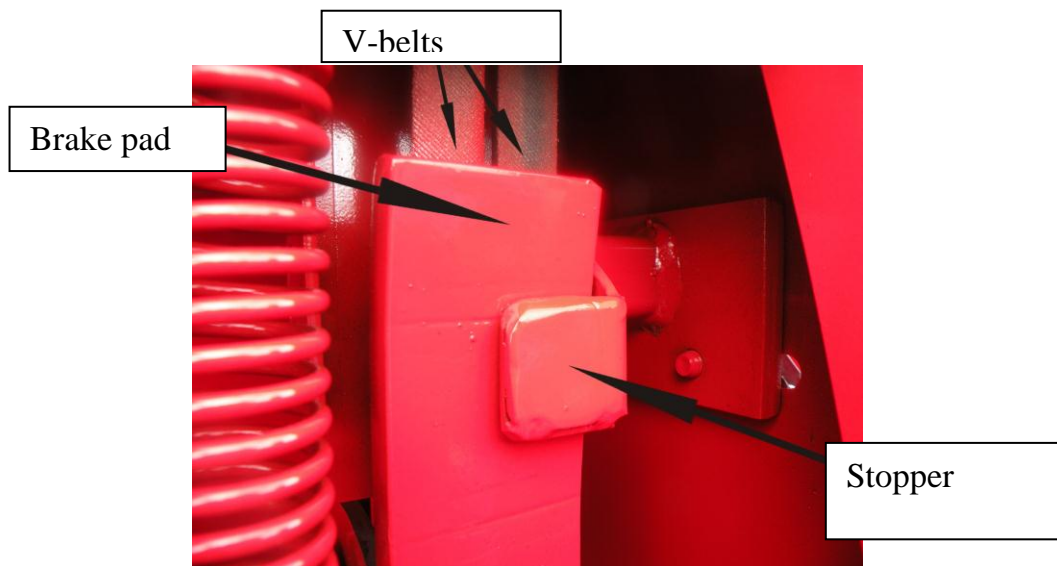
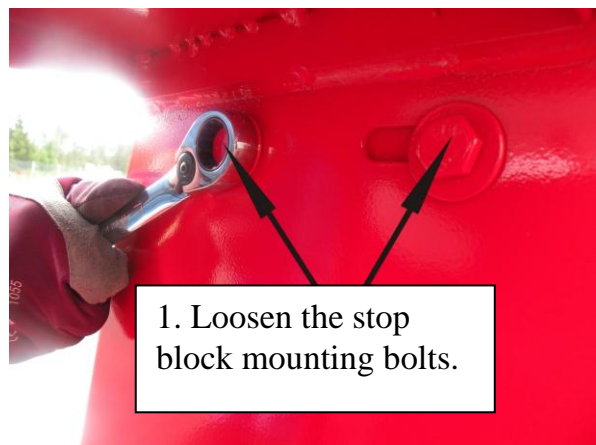
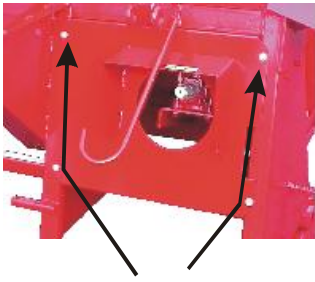

Figure 1

Always start adjusting the belts by loosening the bolts (2 pcs) of the stop block and the stopper attached to it so that the stop block can move while the belts are adjusted. The stop block mounting bolts are located below the splitting cradle. See the figure below.





2. Remove the angular gear cover by removing the cover mounting bolts.

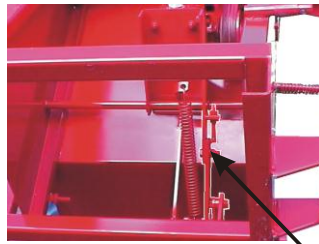

3. Open the locking of the belt adjustment.



4. Open the locking of the adjustment nut. Achieve the correct belt tightness by turning the adjustment nut.

Belt tightness:

The pulley belts should deflect approx. 15 to 20 mm when pushed down.



5. Tighten the adjustment locking nuts.

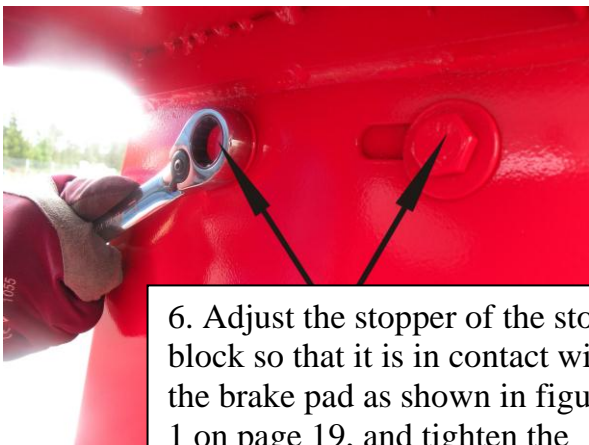
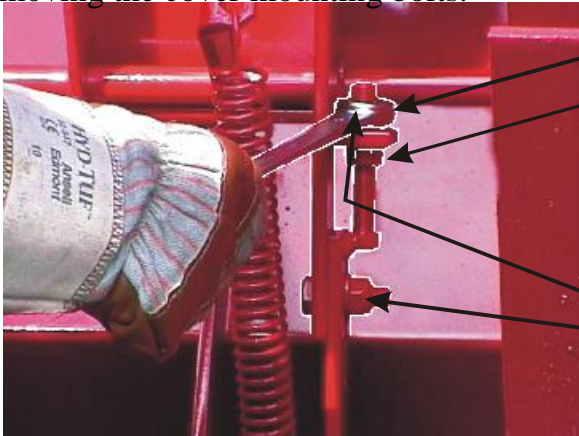

6. Adjust the stopper of the stop block so that it is in contact with the brake pad as shown in figure 1 on page 19, and tighten the bolts. Test that the machine and the emergency stop device operate properly! See page 13!

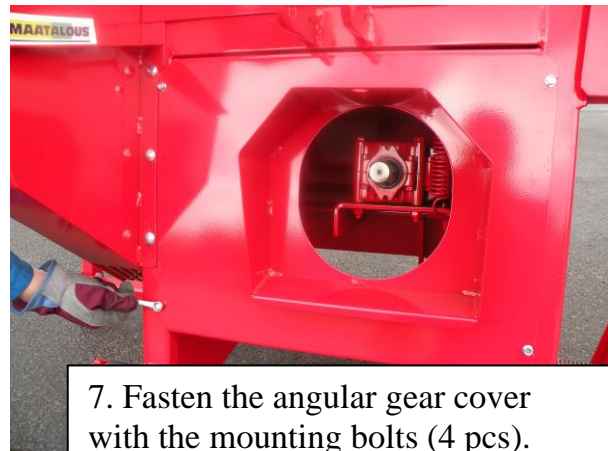

7. Fasten the angular gear cover with the mounting bolts (4 pcs).

Lubrication

Wear appropriate protective clothing to protect your skin when handling lubricants. Handle lubricants appropriately in order to prevent environmental contamination.

Lubricate the points marked with the following yellow symbol with grease every 100 operating hours.



Transporting the Machine

When transporting the machine with a tractor:

- Adjust the cross-cut cradle extension to its shortest position.
- During transport, ensure that the machine does not knock against or collide with other machinery, vegetation, persons, animals, buildings, or other structures along the route.
- Keep the machine at such a distance from the ground that its frame cannot collide with stones, stumps, or other obstacles.
- Transport the machine at a safe speed to prevent damage to the machine or tractor.
- Never carry any extra items on top of the machine during transportation.
- Always lower the machine to the ground during breaks en-route, even for short breaks, and especially when leaving the tractor cab unmanned.

Storing the Machine

- Before putting the machine into storage, clean it by removing all sawdust and other wood debris.
- The machine must be stored in a covered place or, if it is to be stored outdoors, covered with a rain- and snow-proof covering securely attached to the machine.
- The machine must be stored on a level, stable base to prevent tipping. Storing the machine on a slope is strictly forbidden.
- Ensure that the machine is protected from collision during storage.

Technical Specifications

	Tractor-driven	Electrically driven
Length	2800 mm	2800 mm
Depth	900 mm	900 mm
Height	1250 mm	1250 mm
Weight	140 kg	180 kg
Saw blade diameter	700 mm	700 mm
Splitting cone diameter	100 mm	100 mm
Cross-cut cradle length w/ extension	1500 mm	1500 mm
Noise level	A-weighted sound pressure level C-weighted sound pressure level A-weighted sound power level	96.0 dB 99.5 dB 106.0 dB
Vibration	Weighted average, m/s	0.20

Tractor-driven Circular Saw – Exploded View

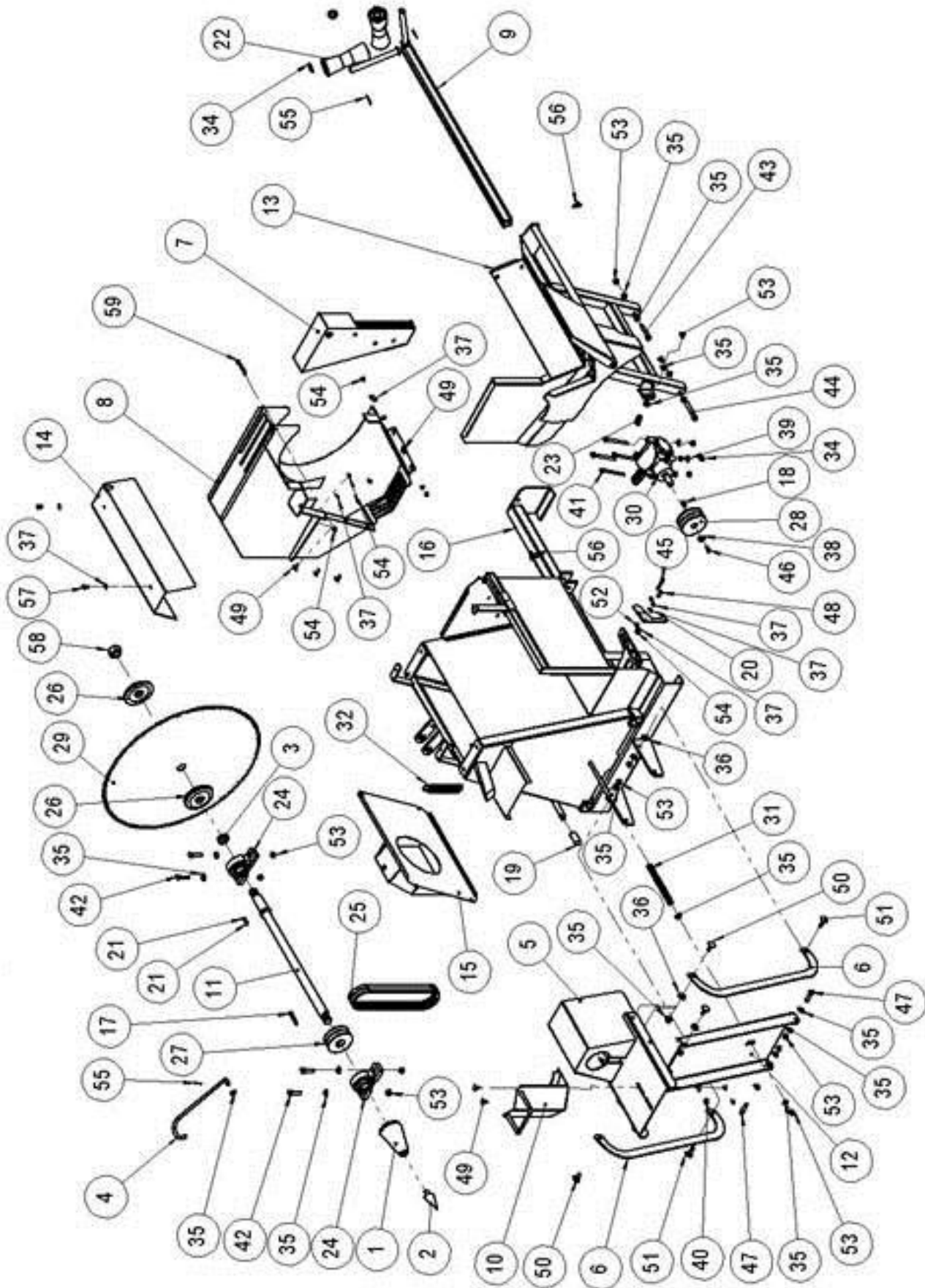

Tractor-driven Circular Saw – Part List

Part	No.	Item	Pcs
1	06032	Cone	1
2	06033	Screw tip	1
3	06035	Shaft retainer	1
4	06057	PTO shaft hook	1
5	06099	Splitting cone cover	1
6	06101	Stabiliser	2
7	06106	Rocking cover	1
8	06108	Saw blade cover	1
9	06114	Table extension rollers, frame	1
10	06137	Splitting table	1
11	06152	Shaft	1
12	06238	Vertical plate	1
13	06240	Cross-cut table	1
14	06253	Shaft cover	1
15	06259	PTO shaft cover	1
16	06270	Circular saw frame, TR	1
17	06330	Key 7x8x65	1
18	06331	Key 6x6x28	1
19	08055b	Pull pin sleeve	2
20	08269	Emergency stop latch	1
21	37077	Key 7x8x15	1
22	95001	Keel roller	2
23	95015	Compression spring 2.5x20x38	1
24	95058	Bearing unit UCP207	2
25	95091	V-belt	2
26	95106	Saw blade support flange	2
27	95116	Pulley	1
28	95117	Pulley	1
29	95141	Tungsten-tipped blade	1
30	95170	Angular gear	1
31	95482	Compression spring 2.5x22x210	1
32	96025	Draw-spring 3.5x30x190	1

33	96049	Washer DIN 125 A10	4
34	96053	Washer DIN 125 A20	2
35	96058	Washer DIN 125 A12	22
36	96059	Washer DIN 125 A16	6
37	96061	Washer DIN 125 A8	11
38	96064	Fender washer DIN 9021 M10	1
39	96068	Locking nut DIN 985 M10	4
40	96082	Fender washer DIN 9021 M8	2
41	96094	Hexagonal screw DIN 931 M10x120	4
42	96108	Hexagonal screw DIN 931 M12x50	4
43	96110	Hexagonal screw DIN 931 M12x70	1
44	96111	Hexagonal screw DIN 931 M12x90	1
45	96124	Hexagonal screw DIN 931 M8x50	1
46	96130	Hexagonal screw DIN 933 10.9M8x20	1
47	96149	Hexagonal screw DIN 933 M12x45	2
48	96164	Hexagonal screw DIN 933 M8x25	1
49	96187	Locking screw DIN 603 M8x20	8
50	96188	Locking screw DIN 603 M12x30	4
51	96189	Locking screw DIN 603 M12x40	2
52	96196	Hexagonal nut DIN 934 M8	2
53	96218	Locking nut DIN 985 M12	16
54	96222	Locking nut DIN 985 M8	10
55	96246	Split pin DIN 94 3.2x32	3
56	96254	Wing screw DIN 316 M8x12	2
57	96315	Hexagonal screw DIN 933 M8x16	2
58	96330	Hexagonal nut DIN 934 M30	1
59	96349	Hexagonal screw DIN 931 M8x120	1

Emergency Stop Device

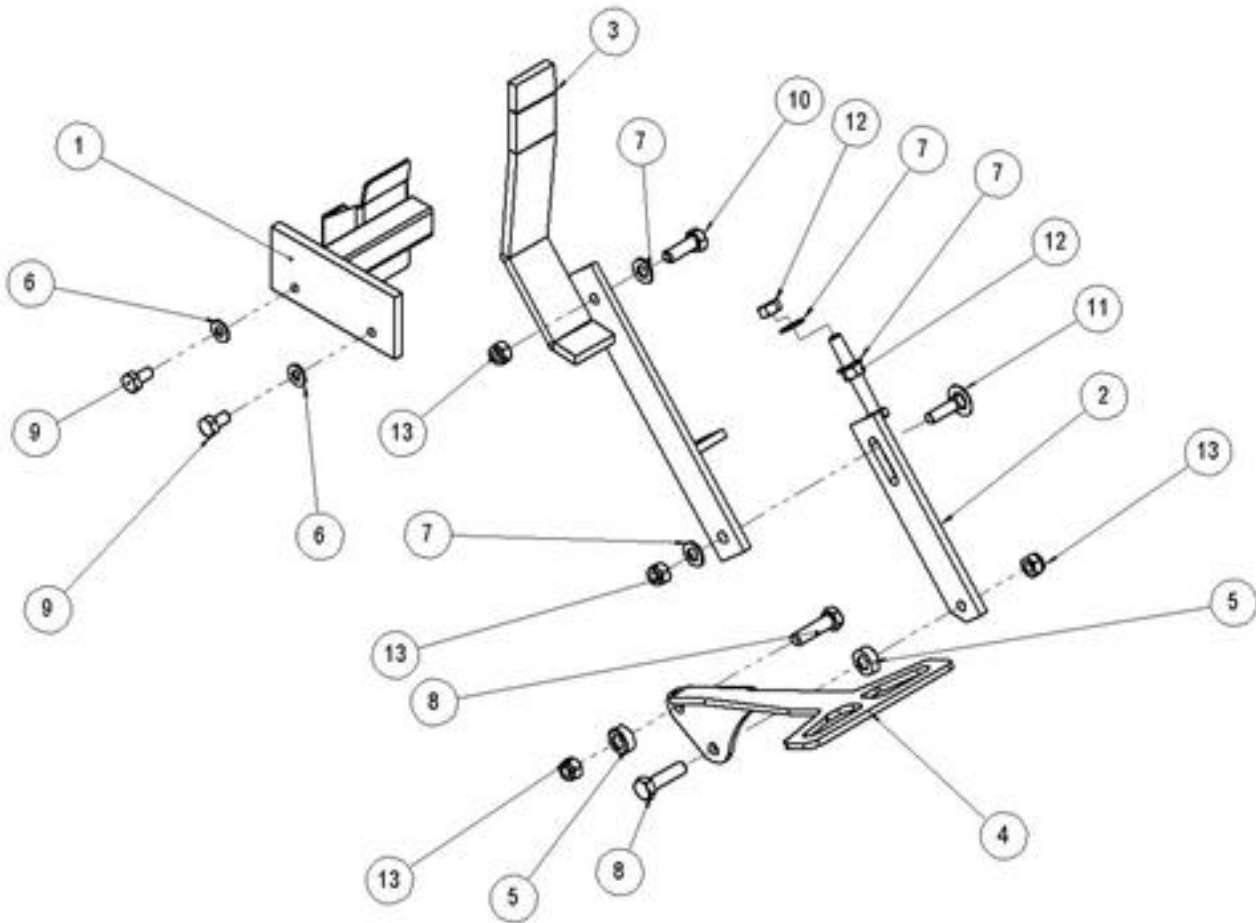

Emergency Stop Device – Spare Part List

Part	No.	Item	Pcs
1	06121	Brake stop block, TR circular saw	1
2	06123	Intermediate bar, emergency stop, TR circular saw	1
3	06276	Brake pad lever	1
4	06341	Emergency stop pedal	1
5	08194	Brake spacer sleeves	2
6	96049	Washer DIN 125 A10	2
7	96058	Washer DIN 125 A12	4
8	96107	Hexagonal screw DIN 931 M12x45	2
9	96138	Hexagonal screw DIN 933 M10x20	2
10	96147	Hexagonal screw DIN 933 M12x35	1
11	96189	Locking screw DIN 603 M12x40	1
12	96200	Hexagonal nut DIN 934 M12	2
13	96218	Locking nut DIN 985 M12	4

Electrically Driven Circular Saw – Exploded View

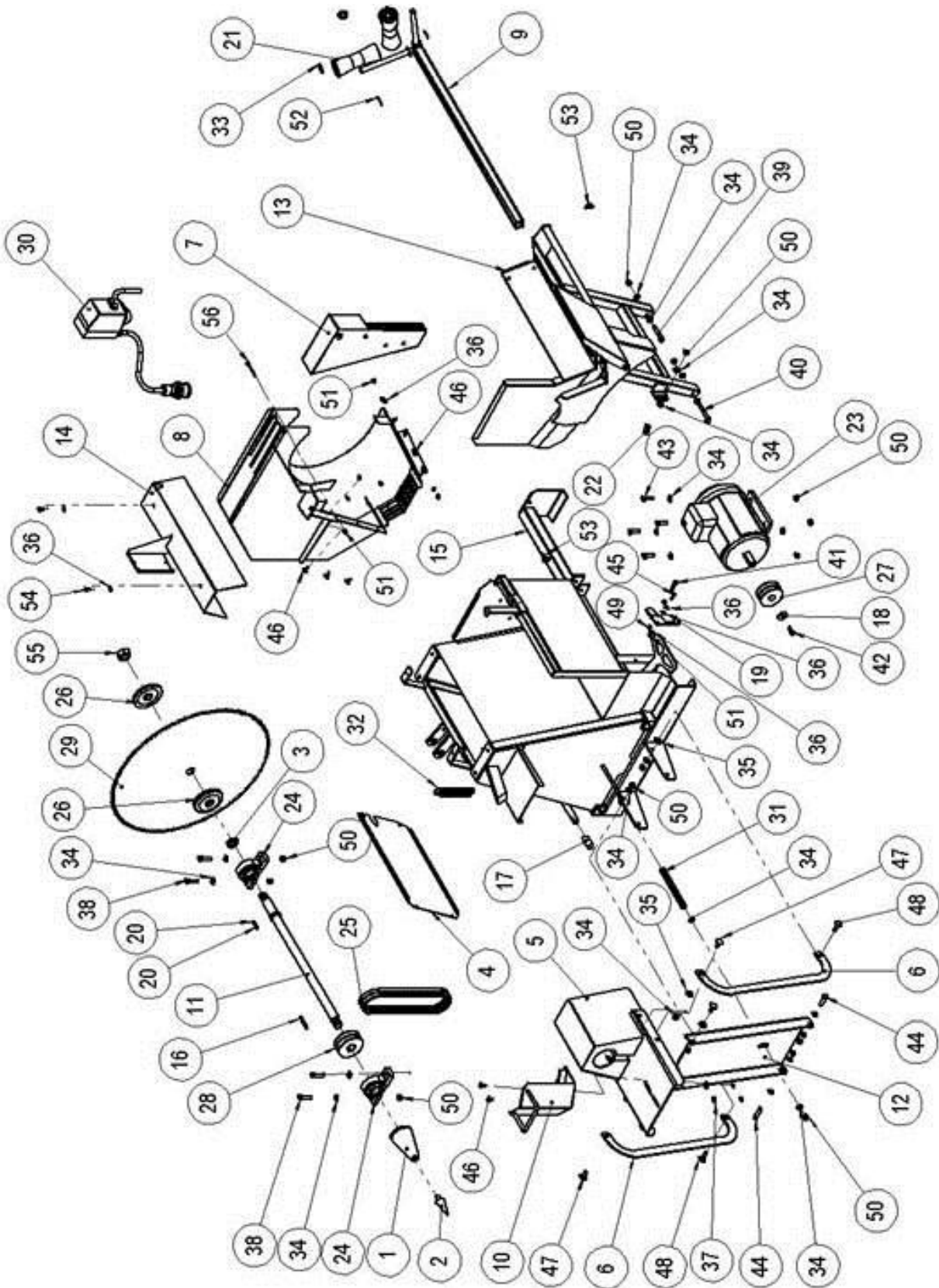

Electrically Driven Circular Saw – Spare Part List

Part	No.	Item	Pcs
1	06032	Cone	1
2	06033	Screw tip	1
3	06035	Shaft retainer	1
4	06070	Rear cover, electrically driven circular saw	1
5	06099	Splitting cone cover	1
6	06101	Stabiliser	2
7	06106	Rocking cover	1
8	06108	Saw blade cover	1
9	06114	Table extension rollers, frame	1
10	06137	Splitting table	1
11	06152	Shaft	1
12	06238	Vertical plate	1
13	06240	Cross-cut table	1
14	06278	Shaft cover, electrically driven model	1
15	06280	Circular saw frame, electrically driven model	1
16	06330	Key 7x8x65	1
17	08055b	Pull pin sleeve	2
18	08099a	Washer	1
19	08269	Emergency stop latch	1
20	37077	Key 7x8x15	1
21	95001	Keel roller	2
22	95015	Compression spring 2.5x20x38	1
23	95036	Electric motor 4 kW	1
24	95058	Bearing unit UCP207	2
25	95091	V-belt	2
26	95106	Saw blade support flange	2
27	95115	V-belt pulley	1
28	95116	Pulley	1
29	95141	Tungsten-tipped blade	1
30	95370	Start box 4 kW	1
31	95482	Compression spring 2.5x22x210	1

32	96025	Draw-spring 3.5x30x190	1
33	96053	Washer DIN 125 A20	2
34	96058	Washer DIN 125 A12	26
35	96059	Washer DIN 125 A16	6
36	96061	Washer DIN 125 A8	8
37	96082	Fender washer DIN 9021 M8	2
38	96108	Hexagonal screw DIN 931 M12x50	4
39	96110	Hexagonal screw DIN 931 M12x70	1
40	96111	Hexagonal screw DIN 931 M12x90	1
41	96124	Hexagonal screw DIN 931 M8x50	1
42	96139	Hexagonal screw DIN 933 M10x40	1
43	96148	Hexagonal screw DIN 933 M12x40	4
44	96149	Hexagonal screw DIN 933 M12x45	2
45	96164	Hexagonal screw DIN 933 M8x25	1
46	96187	Locking screw DIN 603 M8x20	8
47	96188	Locking screw DIN 603 M12x30	5
48	96189	Locking screw DIN 603 M12x40	2
49	96196	Hexagonal nut DIN 934 M8	2
50	96218	Locking nut DIN 985 M12	20
51	96222	Locking nut DIN 985 M8	10
52	96246	Split pin DIN 94 3.2x32	2
53	96254	Wing screw DIN 316 M8x12	2
54	96315	Hexagonal screw DIN 933 M8x16	2
55	96330	Hexagonal nut DIN 934 M30	1
56	96349	Hexagonal screw DIN 931 M8x120	1

Transfer Wheels – Exploded View

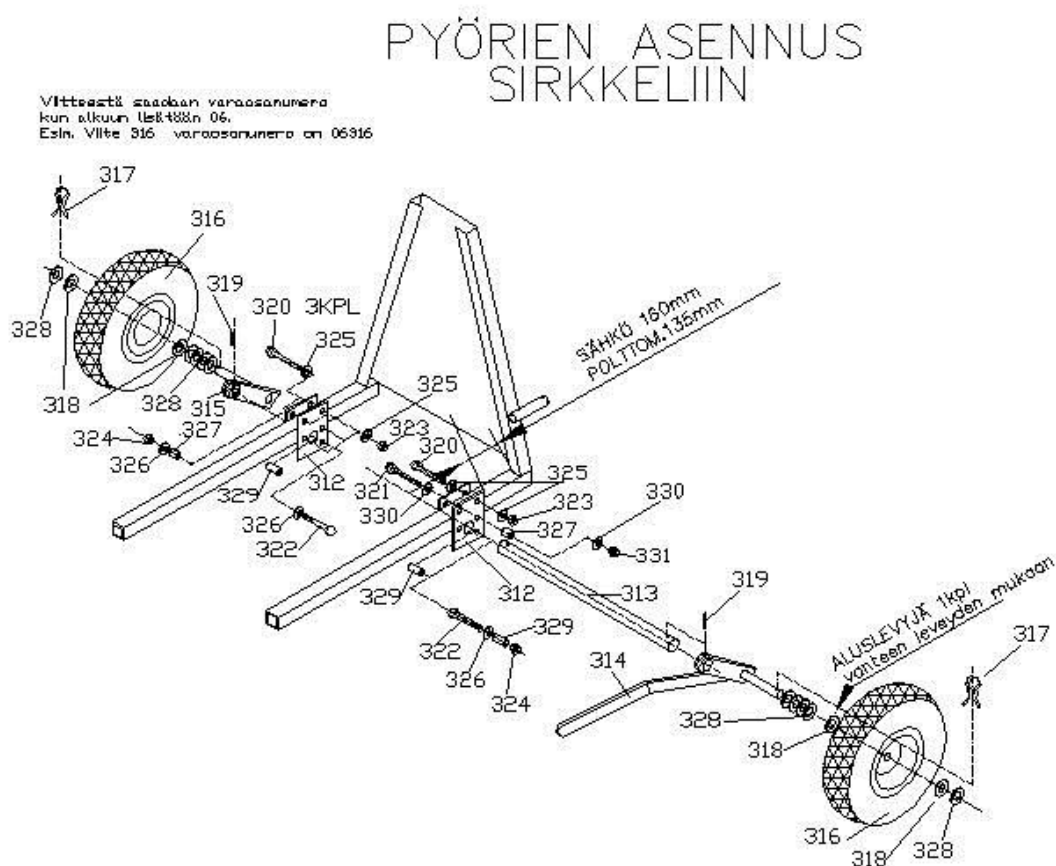

Spare Part List / Installing the Wheels on the Circular Saw

No.	Item	Pcs			
	Installing the Wheels on the Circular Saw		06321	Bolt M10x110	1
			06322	Bolt M12x110	2
			06323	Nut M8 nyloc	7
06312	Mounting plate	4	06324	Nut M12 nyloc	2
06313	Shaft	1	06325	Washer M8	14
06314	Lever + shaft bracket	1	06326	Washer M12	4
06315	Shaft bracket	1	06327	Pipe inner ϕ 12-35	3
06316	Wheel	2	06328	Washer ϕ 21/37	16
06317	Split pin	2	06329	Pipe inner ϕ 12-50	2
06318	Washer ϕ 25/43	4	06330	Washer M10	2
06319	Roll pin ϕ 8x40	2	06331	Nut M10 nyloc	1
06320	Bolt M8x70	7			

EC Declaration of Conformity on the Machine

(Machinery Directive 2006/42/EC, Appendix II A)

Manufacturer: Maaselän Kone Oy
Address: Valimotie 1, 85800 Haapajärvi, Finland

Name and address of the person authorised to compile the technical file:

Name: Juha Autio Address: Valimotie 1, 85800 Haapajärvi, Finland

Declares that

Hakki Pilke Eagle circular saw with splitting device

Serial number:.....

- **complies with the relevant provisions of the Machinery Directive (2006/42/EC);**

Notified body number for Machinery Directive 2006/42/EC: 0504
Type-examination certificate number

EC standards inspection certificate number: 100/2010
Institution approval number 0504
MTT Vakola
Vakolantie 55
03400 Vihti, Finland

Place and date: Haapajärvi, Finland, 1.2.2012



Signed:

Jari Löfroos
Managing Director

WARRANTY TERMS:

Warranty on the products manufactured by Maaselän Kone Oy is subject to the following conditions:

1. The warranty includes all defects arising from manufacturing and material defects, excluding machine components that wear out in normal use.
2. The warranty is valid for one (1) year from the initial purchase of the machine or for a maximum of 1,000 operating hours.
3. The warranty is invalid if the machine has not been used in accordance with the instruction manual or if it has been used for any purpose other than the intended purpose. The warranty is also invalid if parts other than original spare parts have been used or if the scheduled maintenance of the machine has not been carried out.
4. The warranty claim must be presented to the seller or manufacturing plant in writing **immediately** when a defect has been noticed. The customer has to prove that the warranty is valid for the warranty repair to take place.
5. The warranty does not include normal adjustments, user instruction, maintenance, service or cleaning of the machine.
6. The warranty is invalid if the machine or its part has been repaired before the seller, manufacturer or importer has been notified in writing.
7. Warranty repairs must be carried out by a repairer authorised **by the manufacturer or importer**. All cleaning and maintenance costs including oil and fuel are excluded from the warranty.
8. Repair costs are reimbursed according to the rates determined by the manufacturer.
9. The warranty does not cover travelling costs that might occur due to warranty repairs.
10. Spare parts are delivered free of charge using the delivery schedule and method typical of such parts.
11. Special deliveries are paid for by the consignee.